

Operating Instructions

**NE-2156/NE-1856/NE-1456
NE-2146/NE-1846**

2100/1800/1400 Watts Microwave Oven

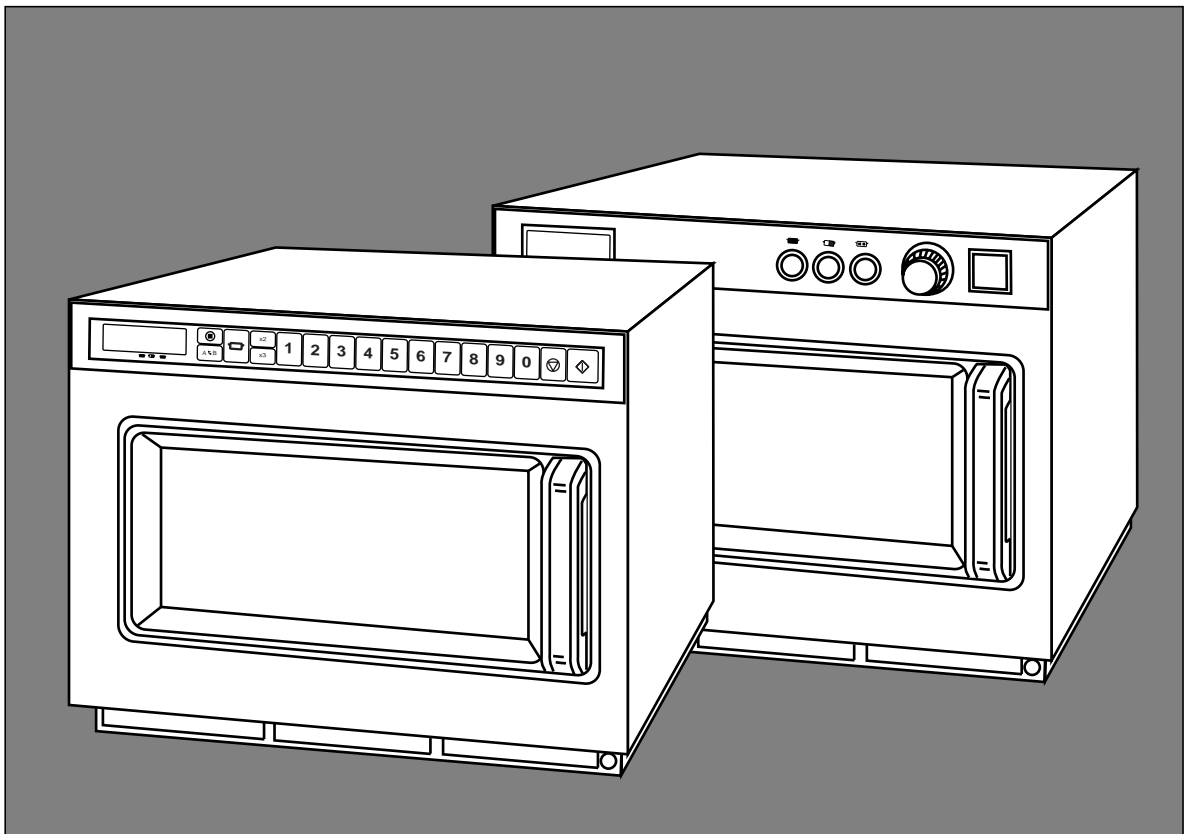

FOR COMMERCIAL USE

Panasonic®

Please read these instructions completely before operating this oven and keep for future reference.

Table of Contents

For Your Safety	2
Unpacking Your Oven	2
Placement of Your Oven	3
Using Your Oven	3
Maintenance of Your Oven	3
Important Safety Instructions —Read Carefully	4 - 5
How Does the Microwave Work?	6
- NE-2146/NE-1846 -	
Outline Diagram	7
How to Operate	7
- NE-2156/NE-1856/NE-1456 -	
Outline Diagram	8
How to Operate	
A. Manual Heating single stage heating	9
2 or 3 stages heating	10
Repeat Feature	10
B. Programmed Heating	11
C. Programming Memory Pads single stage heating	12
2 or 3 stages heating	12
D. Programming Double or Treble Quantity Pad	13
E. Program Lock	13-14
F. Beep Tone	14
G. Program List	15
H. Cycle Counter	15-16
I . Air Filter	16
Installation Instructions for Stacking	17
Self Diagnostics Failure Code	17
Care of Your Microwave Oven	18
Cooking Instructions	19-20
Cooking/Defrosting Guide	21
Technical Specifications	22

For Your Safety

Earthing Instructions

WARNING: THIS APPLIANCE MUST BE EARTHED.



WARNING: (NE-2156/NE-2146)

This appliance must be connected to an outlet having a rated current greater than 13 amps. A 13 amp, B.S. 1363 plug is, therefore, not suitable. It is recommended that this unit should be installed by a professional contractor, as the installation wiring should be in accordance with current IEE regulation and connected to the circuit with all poles having a disconnection of at least 3mm.

When the mains lead is connected to supply terminals, please observe the wiring code as shown below. If in doubt, please consult a qualified electrician.

For model NE-1856/NE-1846/NE-1456

This appliance is supplied with a moulded three pin mains plug for your safety and convenience. A 13 amp fuse is fitted in this plug. Should the fuse need to be replaced, please ensure that the replacement fuse has a rating of 13 amps and that it is approved by ASTA or BSI to BS1362.

Check for the ASTA mark  or the BSI mark  on the body of the fuse.

If the plug contains a removable fuse cover, you must ensure that it is refitted when the fuse is replaced. If you lose the fuse cover, the plug must not be used until a replacement cover is obtained. A replacement fuse cover can be purchased from your local Panasonic Dealer.

HOW TO REPLACE THE FUSE

Open the fuse compartment with a screwdriver and replace the fuse.

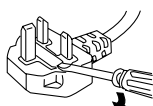

IF THE FITTED MOULDED PLUG IS UNSUITABLE FOR THE SOCKET OUTLET THEN THE FUSE SHOULD BE REMOVED AND THE PLUG CUT OFF AND DISPOSED OF SAFELY AND AN APPROPRIATE ONE FITTED. THERE IS A DANGER OF SEVERE ELECTRICAL SHOCK IF THE CUT OFF PLUG IS INSERTED INTO ANY 13 AMP SOCKET.

If a new plug is to be fitted, please observe the wiring code as shown below. If in any doubt, please consult a qualified electrician.

IMPORTANT: The wires in this mains lead are coloured in accordance with the following code:

Green-and-yellow:	Earth
Blue:	Neutral
Brown:	Live

As the colours of the wire in the mains lead of this appliance may not correspond with the coloured markings identifying the terminals, proceed as follows:

The wire which is coloured GREEN-AND-YELLOW must be connected to the terminal which is marked with the letter E or by the Earth symbol  or coloured GREEN or GREEN-AND-YELLOW.

The wire which is coloured BLUE must be connected to the terminal which is marked with the letter N or coloured BLACK.

The wire which is coloured BROWN must be connected to the terminal which is marked with the letter L or coloured RED.

Voltage & Power

The voltage used must be the same as specified on this microwave oven. Using a higher voltage than that which is specified is dangerous and may result in a fire or other type of accident causing damage.

Do not immerse cord, plug or oven in water. Keep cord away from heated surfaces. Do not let cord hang over the edge of table or worktop. Do not plug your oven in via an extension cable as this can be dangerous. It is important to plug the oven directly into a wall socket.

The back of the appliance heats up during use. Do not allow the cord to be in contact with the back of the appliance or cabinet surface.

Unpacking Your Oven

1. Examine Your Oven

Unpack the oven, remove all packing material, and examine the oven for any damage such as dents, broken door latches or cracks in the door. Notify dealer immediately if the unit is damaged. **DO NOT** install it if the unit is damaged.

2. Guarantee Card

Fill out and post the pre-addressed guarantee card.

3. Cord

If the supply cord of this appliance is damaged, it must be replaced by the manufacturer or its service agent or a similarly qualified person in order to avoid a hazard.

4. Door Seal

The appliance should be inspected for damage to the door seals and door seal areas and if these areas are damaged the appliance should not be operated until it has been repaired by service technician trained by the manufacturer.

5. Removal of protective film

A protective film is used to prevent scratching of the outer case during transportation. Peel this film off before installation or use.

6. Attach caution label

If a caution label is enclosed with your oven, please attach it to the top of the appliance before using.

Placement of Your Oven

1. Oven must be placed on a flat, stable surface. For proper operation, the oven must have sufficient air flow to the air vents i.e. 5 cm (2 inches) at the side and rear; 20 cm (8 inches) at the top.
2. Do not place the microwave oven on a shelf directly above a gas or electric hob. This may be a safety hazard and the oven may be damaged. It is dangerous to position this oven on a shelf which is so high that food cannot be safely removed by the user. The oven may be stacked. (see page 17)
3. Do not block air vents on the rear and bottom of the cabinet. If air vents are blocked during operation, the oven may overheat. If the oven overheats, a thermal safety device will turn the oven off. The oven will remain inoperable with blank display until it has cooled.
4. Do not use the oven outdoors.

Using Your Oven

1. This oven must not be operated without food in the oven. Operation when empty will damage the appliance.
2. Children should be kept away from the oven at all times and should only be allowed to operate the oven under supervision.
3. Storage of accessories. Do not store any objects inside the oven in case it is accidentally turned on. In case of electronic failure, the oven can be turned off at wall socket.
4. Do not dry fabrics in the oven since there is a possibility of the clothes burning if left in the oven for too long.
5. If smoke is observed, press the **Stop/Reset Pad** or turn the **Timer Dial** back to zero "0" position and leave the door closed. Disconnect the power cord, or shut off the power at the fuse or circuit breaker panel.



Maintenance of Your Oven

1. WHEN YOUR OVEN REQUIRES A SERVICE call your local Panasonic engineer (08701-591590) for service. It is dangerous for anyone other than a service technician trained by the manufacturer to perform repair service. Do not attempt to remove the outer casing of the oven.
2. Do not attempt to tamper with or make any adjustments or repairs to the door, control panel housing, safety interlock switches or any other part of the oven. **Do not remove outer panel from the oven.** The door seals and door seal areas should always be kept clean — use a damp cloth.
3. The oven lamp must be replaced by a service technician trained by the manufacturer. DO NOT attempt to remove the outer casing from the oven.



Important Safety Instructions — Read Carefully

Short Cooking Times

As microwave cooking times are much shorter than other cooking methods it is essential that recommended cooking times are not exceeded without first checking the food.

Factors that may affect cooking times are: preferred degree of cooking, starting temperature, altitude, volume, size and shape of foods and utensils used. As you become familiar with the oven, you will be able to adjust these factors.

It is better to undercook rather than overcook foods. If food is undercooked, it can always be returned to the oven for further cooking. If food is overcooked, nothing can be done. Always start with minimum cooking times.

IMPORTANT

If the recommended cooking times are exceeded, the food will be spoiled and in extreme circumstances it could catch fire and possibly damage the interior of the oven.

1. Small Quantities of Food

Take care when heating small quantities of food as these can easily burn, dry out or catch on fire if cooked too long. Always set short cooking times and check the food frequently.

N.B. If materials inside the oven should ignite, keep the oven door closed, turn the oven off.

Disconnect the power cord, or shut off the power at the fuse or circuit breaker panel.

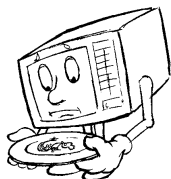

NEVER OPERATE THE OVEN WITHOUT FOOD.

2. Foods Low in Moisture

Take care when heating foods low in moisture, e.g. bread items, chocolate, popcorn, biscuits and pastries. These can easily burn, dry out or catch on fire if cooked too long.

3. Christmas Pudding

Christmas puddings and other foods high in fats or sugar, e.g. jam, mince pies, must not be over heated. These foods must never be left unattended as with over cooking these foods can ignite.

4. Boiled Eggs

Do not boil eggs in their shells in the microwave. Raw eggs boiled in their shells can explode causing injury.

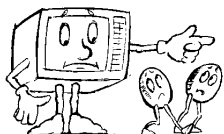

5. Foods with Skins

Potatoes, apples, egg yolk, whole vegetables and sausages are examples of food with non porous skins. These must be pierced using a fork before cooking to prevent bursting.



6. Liquids

When heating liquids, e.g. soup, sauces and beverages in your microwave oven, overheating the liquid beyond boiling point can occur without evidence of bubbling. This could result in a sudden boil over of the hot liquid. To prevent this possibility the following steps should be taken:

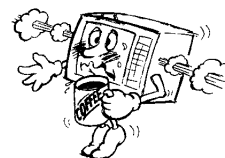

- Avoid using straight-sided containers with narrow necks.
- Do not overheat.
- Stir the liquid before placing the container in the oven and again halfway through the heating time.
- After heating, allow it to stand in the oven for a short time, stirring again before carefully removing the container.

7. Lids

Always remove the lids of jars and containers and take away food containers before you microwave them. If you don't, steam and pressure might build up inside and cause an explosion even after the microwave cooking has stopped.

8. Deep Fat Frying

Do not attempt to deep fat fry in your oven.

9. Temperature probe

Use a temperature probe to check the temperature of foods when they have been removed from the microwave. If undercooked, return to the oven and cook for a few more minutes at the recommended power level. Do not leave the temperature probe in the oven when microwaving.

10. Paper, Plastic

When heating food in plastic or paper containers, check the oven frequently as these types of containers ignite if overheated. Do not use wire twist-ties with roasting bags as arcing will occur. Do not use recycled paper products, e.g. kitchen roll unless they say they are specifically designed for use in a microwave oven. These products contain impurities which may cause sparks and/or fires when used.

Important Safety Instructions — Read Carefully

11. Reheating

It is essential that reheated food is served “piping hot”. Remove the food from the oven and check that it is “piping hot”, i.e. steam is being emitted from all parts and any sauce is bubbling. If you wish you may choose to check the food has reached 72°C with a food thermometer – (but remember do not leave this thermometer inside the microwave.) or to a temperature recommended by Government Food Hygiene Regulations.

For foods that cannot be stirred, e.g. lasagne, shepherds pie, the centre should be cut with a knife to test it is well heated through. Even if a manufacturer’s packet instructions have been followed, always check the food is piping hot before serving it. If in doubt return your food to the oven for further heating.

12. Standing Time



Standing time refers to the period at the end of cooking or reheating when food is left before being eaten, i.e. it is a rest time which allows the heat in the food to continue to conduct to the centre, thus eliminating cold spots.

13. Keeping Your Oven Clean

It is essential for the safe operation of the oven that it is wiped out regularly. Use warm soapy water or a food sanitizer solution. Squeeze the cloth out well and use it to remove any grease or food from the interior.

Pay particular attention to the door seal area and also the removable splatter shield.

(see page 18)

Disconnect the appliance from the electricity supply before cleaning.



14. Babies Bottles and Food Jars

When reheating babies bottles always remove top and teat. Liquid at the top of the bottle will be much hotter than at the bottom and must be shaken thoroughly before checking the temperature. The lid must also be removed from babies food jars, the contents must also be stirred or shaken before the temperature is checked. The temperature has to be checked before consumption to avoid burns.

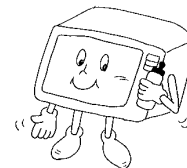

15. Containers

Before use check that utensils/containers are suitable for use in microwave ovens.

DO NOT USE METAL UTENSILS IN THIS OVEN.

16. Sealed Containers

Liquids or other foods must not be heated in sealed containers since they are liable to explode.

How Does the Microwave Work?

Microwaves are a form of high frequency radio waves similar to those used by a radio including AM, FM and CB. They are, however, much shorter than radio waves; approximately 12 cm long. Electricity is converted into microwave energy by the magnetron tube. From the magnetron tube, microwave energy is transmitted and absorbed.

Reflection

Microwaves are reflected by metal just as a ball is bounced off a wall. A combination of stationary (interior walls) and rotating antenna, located underneath the bottom shelf and above the ceiling cover assure that the microwaves are well distributed within the oven cavity to produce even heating or cooking of foods.

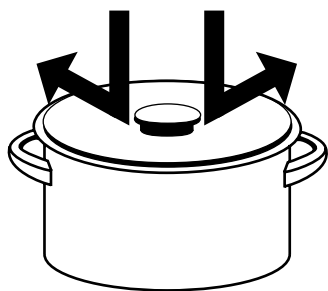

Transmission

Microwaves pass through some materials such as paper, glass and plastic much like sunlight shining through a window. Because these substances do not absorb or reflect the microwave energy, they are ideal materials for microwave oven cooking containers.

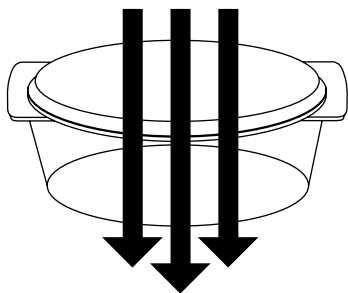

Absorption

During heating, microwaves will be absorbed by food. They penetrate to a depth of about 1-5 cm. Microwave energy excites the molecules in the food (especially water, fat and sugar molecules), and causes them to vibrate at a rate of 2,450,000,000 times per second. This vibration causes friction, and heat is produced just as you will feel heat produced if you vigorously rub your hands together. The internal heating of larger foods is done by conduction. The heat which is produced by friction travels by conduction to the centre of the food. Foods also continue to heat by conduction during standing time.

Because microwaves dissipate, much like sunlight as it reaches the Earth's surface, they are not stored in food.

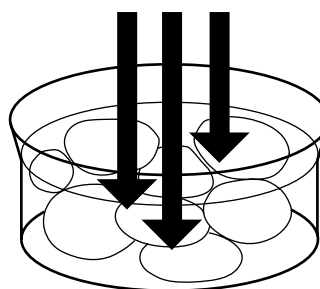

Radio Interference

1. Operation of the microwave oven may cause interference to your radio, TV or similar equipment.
2. When there is interference, it may be reduced or eliminated by taking the following measures:
 - a. Clean the door and sealed surfaces of the oven. (See Care of Your Microwave Oven found on page 18.)
 - b. Place the radio, TV, etc. as far away as possible, from the microwave.
 - c. Use a properly installed antenna, to obtain stronger signal reception.

Outline Diagram NE - 2146/NE - 1846

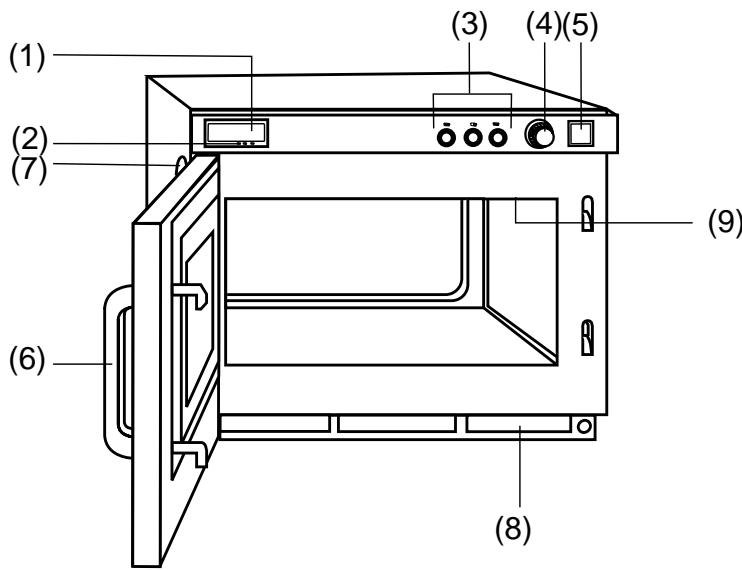

- (1) Digital Display Window (see below)
- (2) Power Level Indicator Display
- (3) Power Level Selector Buttons
- (4) Timer Dial
- (5) Start Button
- (6) Door Handle
- (7) Oven Lamp Cover
- (8) Air Filter
- (9) Splatter Shield (top of inner cavity)

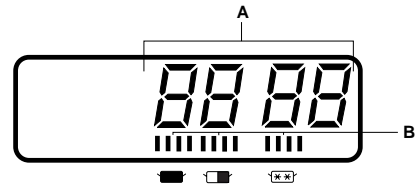

- A — Heating Time Display (min. sec.)
- B — Power Level Indicator
- : HIGH
- : MEDIUM
- ☒ : DEFROST

How to Operate NE - 2146/NE - 1846

Example: To cook food at MEDIUM power for 4 minutes

	PAD	INSTRUCTION	DIGITAL DISPLAY WINDOW
1		Open the door and put the food in the oven. ⚡ The oven lamp will turn on. "0" and Power Level Indicator ■ will appear. Note: While "0" appears, operation is available. One minute after the door is closed, "0" will disappear.	
2		Press the desired Power Level Selector Button, if other than ■ (HIGH).	
3		Set heating time. ⚡ The heating time will appear in the digital display while turning the Timer Dial. Note: up to 25 min. on ■, 30 min. on □ or ☒	
4		Press Start Button. ⚡ The oven lamp will turn on and heating will start. Power Level Indicator will start to blink, and heating time will count down.	
<ul style="list-style-type: none"> When all time expires, beep tone will sound and heating will stop. The oven lamp will turn off. "0" will blink until the door is opened. One minute later, cooling fan will stop. Open the door and take the food out. The oven lamp will turn on. Digital Display Window will show "0" and Power Level Indicator ■ Close the door. The oven lamp will turn off. One minute later, Digital Display Window will go blank. When you press the Start Button with door open, "0" will appear in the display in all cases. Even after setting the heating time you can still change the power level. If you wish to change the heating time during heating, simply adjust the timer to desired minutes and seconds. 			

Outline Diagram NE - 2156/NE - 1856/NE - 1456

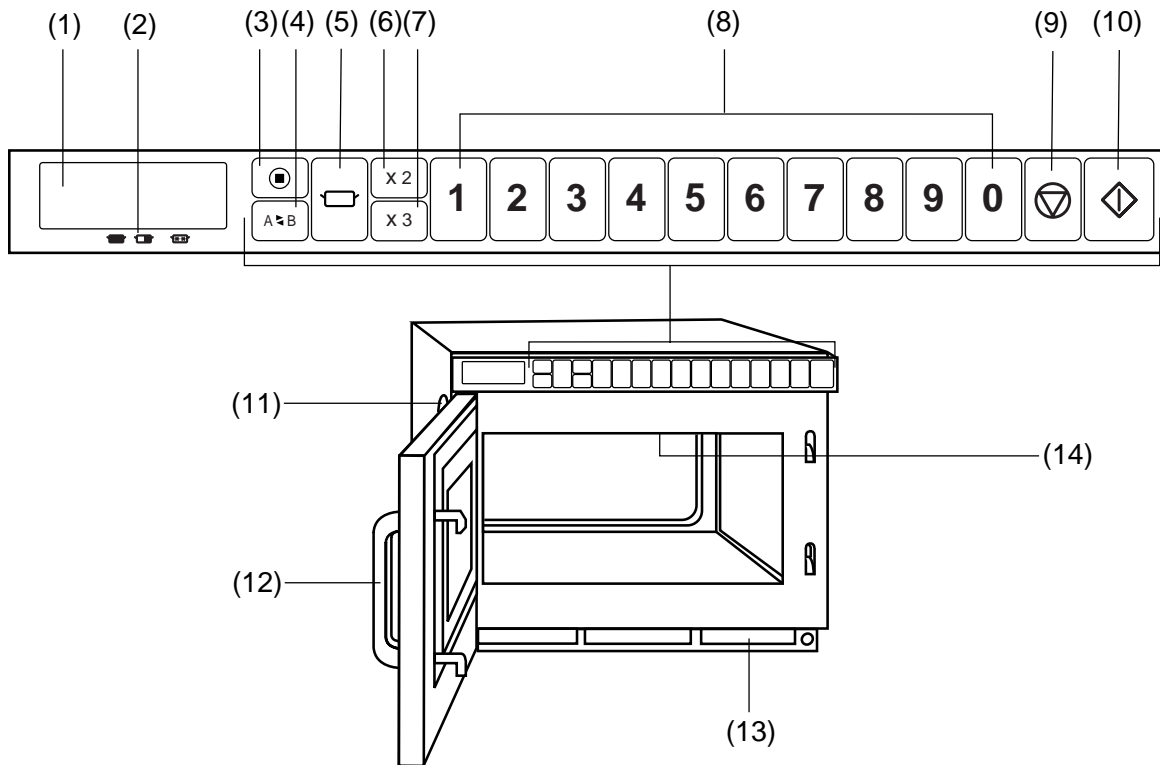

- (1) Digital Display Window (see below)
- (2) Power Level Indicator Display
- (3) Program pad
- (4) Shift (A/B) pad
- (5) Power Level Selector pad
- (6) Double Quantity pad
- (7) Treble Quantity pad

- (8) Number/Memory pads
- (9) Stop/Reset pad
- (10) Start pad
- (11) Oven Lamp Cover
- (12) Door Handle
- (13) Air Filter
- (14) Splatter Shield (top of inner cavity)

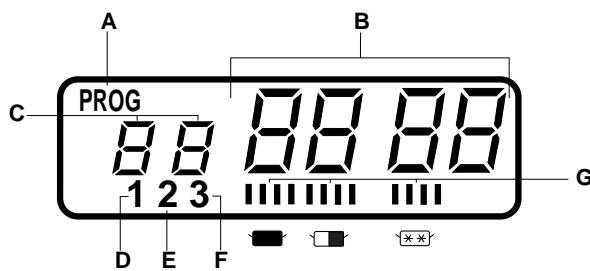

- A — Program Display
- B — Heating Time Display (min. sec.)
- C — Memory Pad Number Display
- D — 1st Stage Heating Indicator
- E — 2nd Stage Heating Indicator
- F — 3rd Stage Heating Indicator
- G — Power Level Indicator
 - : HIGH
 - ▒ : MEDIUM
 - : DEFROST







This oven is preset at the factory for the following:

- ◆ Manual operation
 - ◆ Number/Memory pads preset HIGH power at the indicated heating times for single stage heating
 - 1 = 10 sec. 2 = 20 sec. 3 = 30 sec. 4 = 40 sec. 5 = 50 sec.
 - 6 = 1 min. 7 = 1 min. 15 sec. 8 = 1 min. 30 sec. 9 = 1 min. 45 sec. 0 = 2 min.
 (There are two sides, A and B. Only A-side is preset.)
 - ◆ Program Unlock
 - ◆ Cycle Counter set to "0" on all pads
- If you wish to change these times, please consult the operating instructions to find how to program them.

How to Operate NE - 2156/NE - 1856/NE - 1456

A. MANUAL HEATING — single stage heating —



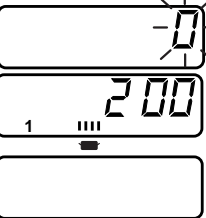





Example: To cook food at HIGH power for 2 minutes

	PAD	INSTRUCTION	DIGITAL DISPLAY WINDOW
1		<p>Open the door and put the food in the oven. ⚡ The oven lamp will turn on and "0" will appear. Note: While "0" appears, operation is available. One minute after the door is closed, "0" will disappear.</p>	
2		<p>Press Power Level Selector pad once. ⚡ The selected power level will be indicated and 1st Stage Heating Indicator "1" will start to blink. Note: To select HIGH power, press once. To select MEDIUM power, press twice. To select DEFROST power, press three times.</p>	
3		<p>Press Number/Memory pads "2", "0" and "0". ⚡ The set heating time will appear. Note: up to 15 min. on HIGH or MEDIUM power, 30 min. on DEFROST</p>	
4		<p>Press Start pad. ⚡ The oven lamp will turn on and heating will start. Power Level Indicator will start to blink, and heating time will count down.</p>	
<ul style="list-style-type: none"> • When all time expires, beep tone will sound and heating will stop. The oven lamp will turn off. "0" will blink until the door is opened. One minute later, cooling fan will stop. • Open the door and take the food out. The oven lamp will turn on. Digital Display Window will show the originally selected time and power. • Close the door. The oven lamp will turn off. One minute later, Digital Display Window will go blank. 			

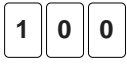
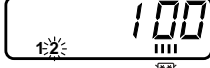
How to Operate NE - 2156/NE - 1856/NE - 1456

A. MANUAL HEATING — 2 or 3 stages heating —

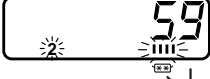
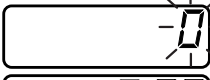
Example: To cook food at HIGH power for 2 minutes and at DEFROST power for 1 minute

	PAD	INSTRUCTION	DIGITAL DISPLAY WINDOW
		Follow steps 1 to 3 on page 9.	
4		Press Power Level Selector pad three times. ☛ The selected power level will be indicated and 2nd Stage Heating Indicator "2" will start to blink.	
5		Press Number/Memory pads "1", "0" and "0". ☛ The set heating time will appear. Note: up to 15 min. on HIGH or MEDIUM power, 30 min. on DEFROST	
6		Press Start pad. ☛ The oven lamp will turn on. The total time for both stages will appear and start to count down. 1st Stage Heating Indicator "1" and Power Level Indicator for the first stage heating will start to blink.	 
		<ul style="list-style-type: none"> • After the first stage heating, beep tone will sound. 2nd Heating Stage Indicator "2" and Power Level Indicator for the second stage heating will start to blink and the remaining heating time will count down. • When all time expires, beep tone will sound and heating will stop. The oven lamp will turn off. "0" will blink until the door is opened. One minute later, cooling fan will stop. • Open the door and take the food out. The oven lamp will turn on. Digital Display Window will show the originally set time and power. • Close the door. The oven lamp will turn off. One minute later, Digital Display Window will go blank. 	   

Note: For 3 stages heating, select a power level once again after step 5 and set a heating time.

SPECIAL NOTE: For both single and 2 stages heating

1. While heating, one touch on Stop/Reset pad stops the operation. You can restart it by pressing Start pad or a second touch on Stop/Reset pad will cancel the selected program.
2. While not heating, one touch on Stop/Reset pad cancels the selected program.

Repeat Feature

- You can repeat the last manually selected heating time by pressing the Start pad  , if the oven is used within 1 minute.
- After 1 minute of non-use with the door closed, the Repeat Feature will be cancelled. The display goes blank.

How to Operate NE - 2156/NE - 1856/NE - 1456

B. PROGRAMMED HEATING

◆ In Program Unlock Mode:

Example: To select Number/Memory pad "3" at A side in which your desired heating program (at HIGH power for 3 min., single stage heating) is set

	PAD	INSTRUCTION	DIGITAL DISPLAY WINDOW
1		Open the door and put the food in the oven. ⚡ The oven lamp will turn on and "0" will appear. Note: While "0" appears, operation is available. One minute after the door is closed, "0" will disappear.	
2		Press the desired Number/Memory pad "3". ⚡ The currently programmed information will be indicated.	
3		Press Start pad. ⚡ The oven lamp will turn on and heating will start. The heating time will count down.	
<ul style="list-style-type: none"> • When all time expires, beep tone will sound and heating will stop. The oven lamp will turn off. "0" will blink until the door is opened. One minute later, cooling fan will stop. • Open the door and take the food out. The oven lamp will turn on. • Close the door. The oven lamp will turn off. One minute later, Digital Display Window will go blank. 			

Note:

- When you want to select the number at B side, press Shift (A/B) pad before pressing the desired Number/Memory pad.

◆ In Program Lock Mode:

Just press the desired Number/Memory pad. Heating will automatically start without pressing Start pad.

◆ For Double (or Treble) Quantity heating:

Press Double (or Treble) Quantity pad before pressing the desired Number/Memory pad.







C. PROGRAMMING NUMBER/MEMORY PADS — single stage heating —

**THE OVEN CAN NOT BE PROGRAMMED WHEN PROGRAM LOCK IS ACTIVATED! (see page 13-14)
DO NOT OPEN THE DOOR WHILE PROGRAMMING!**

Example: To program cooking at DEFROST power for 1 minute into Number/Memory pad "5"

	PAD	INSTRUCTION	DIGITAL DISPLAY WINDOW
1		Keep the door closed. ⚡ Digital Display Window must be blank.	
2		Press Program pad. ⚡ "PROG" will start to blink.	

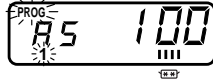
How to Operate NE - 2156/NE - 1856/NE - 1456

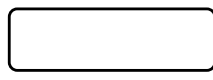
3		Press Number/Memory pad "5". The selected pad number will appear and currently programmed information will be indicated.	
4		Press Power Level Selector pad three times. The selected power level will be indicated, 1st Stage Heating Indicator "1" will start to blink, and Heating Time Display will go blank.	
5		Press Number/Memory pads "1", "0" and "0". The set heating time will appear. Note: up to 15 min. on HIGH or MEDIUM power, 30 min. on DEFROST	
6		Press Program pad. "PROG" and 1st Stage Heating Indicator "1" will stop blinking. This means that you have completed programming.	
<ul style="list-style-type: none"> Three seconds later, Digital Display Window will go blank. 			







Note:

- Program the remaining Number/Memory pads as desired by repeating steps 1-6 above.
- When "PROG" is blinking in Digital Display Window, the program can be cancelled and/or one touch on Stop/Reset pad erases the programmed Number/Memory pad number.
- When you want to program the B side, press Shift (A/B) pad before selecting the desired Number/Memory pad.

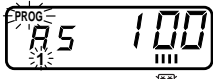
C. PROGRAMMING NUMBER/MEMORY PADS — 2 or 3 stages heating —

**THE OVEN CAN NOT BE PROGRAMMED WHEN PROGRAM LOCK IS ACTIVATED! (see page 13-14)
DO NOT OPEN THE DOOR WHILE PROGRAMMING!**

Example: To program cooking at DEFROST power for 1 minute and at HIGH power for 2 minutes into Number/Memory pad "5"

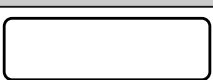
	PAD	INSTRUCTION	DIGITAL DISPLAY WINDOW
		Follow steps 1 to 5 above.	
6		Press Power Level Selector pad once. The power level for 2nd stage will be indicated, 2nd Stage Heating Indicator "2" will start to blink, and Heating Time Display will go blank.	
7		Press Number/Memory pads "2", "0" and "0". The set heating time will appear. Note: up to 15 min. on HIGH or MEDIUM power, 30 min. on DEFROST	
8		Press Prog pad. "PROG" and 2nd Stage Heating Indicator "2" will stop blinking. The total time for both stages will appear. This means that you have completed programming.	
<ul style="list-style-type: none"> Three seconds later, Digital Display Window will go blank. 			

Note:

- Program the remaining Number/Memory pads as desired by repeating steps above.
- When "PROG" is blinking in Digital Display Window, the program can be cancelled and/or one touch on Stop/Reset pad erases the programmed Number/Memory pad number.
- When you want to program the B side, press Shift (A/B) pad before pressing Number/Memory pad.

How to Operate NE - 2156/NE - 1856/NE - 1456

D. PROGRAMMING DOUBLE OR TREBLE QUANTITY PAD

THE OVEN CAN NOT BE PROGRAMMED WHEN PROGRAM LOCK IS ACTIVATED! (see below)
DO NOT OPEN THE DOOR WHILE PROGRAMMING!

Example: To program 1.5 times of heating time for double quantity into Number/Memory pad "5"

PAD	INSTRUCTION	DIGITAL DISPLAY WINDOW
1	Keep the door closed. ☛ Digital Display Window must be blank.	
2	Press Prog pad. ☛ "PROG" will start to blink.	
3	Press Number/Memory pad "5". ☛ The selected pad number will appear and currently programmed information will be indicated.	
4	Press Double Quantity pad. ☛ The currently programmed magnification number will appear. Note: 1.6 times is preset at factory.	
5	Press Number/Memory pads "1" and "5". ☛ The programmed magnification number will appear.	
6	Press Prog pad. ☛ "PROG" will stop blinking. This means that you have completed programming.	
<ul style="list-style-type: none"> • Three seconds later, Digital Display Window will go blank. 		

Note:

- If you want to program your desired magnification number for treble quantity, repeat as above, using Treble Quantity pad instead of Double Quantity pad.

E. PROGRAM LOCK

◆ To Activate Program Lock:

PAD	INSTRUCTION	DIGITAL DISPLAY WINDOW
1	Keep the door closed. ☛ Digital Display Window must be blank.	
2	Press Prog pad until "PROG", "P" and "L" appear. (more than five seconds) ☛ "PROG", "P" and "L" will appear.	

In Program Lock mode:

- The oven is started by pressing the desired Number/Memory pad. There is no need to press Start pad.
- Opening the door cancels the remaining time on the program.
- The oven can not be programmed or run manually until the program lock is released.

How to Operate NE - 2156/NE - 1856/NE - 1456

◆ To Release Program Lock:

	PAD	INSTRUCTION	DIGITAL DISPLAY WINDOW
1		Open the door and leave it open. ⚡ The oven lamp will turn on, and "0" will appear.	
2	+	While pressing Stop/Reset pad, press Prog pad until "PROG" and "P" appear. (more than five seconds) ⚡ "PROG" and "P" will appear.	

In Program Unlock mode:

- Oven reverts to a two-touch operating mode (Number/Memory pad + Start pad).
- Repeat and interrupt feature are operational.
- Number/Memory pads can be programmed.
- Tone loudness control and length control are operational.

F. BEEP TONE

The loudness of beep tone and the length of beep tone at the end of heating cycle can be set.

There are four levels of the loudness. The level is indicated by a number followed by the word "bEEP".

- 3bEEP = loudest
- 2bEEP = middle
- 1bEEP = quietist
- 0bEEP = silent

There are two options of the length of beep tone at the end of heating cycle. The length is indicated by 1 st or 2 nd Stage Heating Indicator.

- 1 = 3 beeps
- 2 = short beeps for 60 seconds

The loudest level and 3 beeps are preset at the factory.

◆ To Select Loudness Level and Length "3 beeps":

Example: To select loudest beep tone

	PAD	INSTRUCTION	DIGITAL DISPLAY WINDOW
1		Open the door and leave it open. ⚡ The oven lamp will turn on and "0" will appear.	
2		Press Prog pad.	
3		Press Number/Memory pad "0" once. ⚡ The tone will sound at its loudness level and the loudness level "3" followed by the word "bEEP" will appear. "PROG" will start to blink and 1st Stage Heating Indicator "1" (the length of beep tone "3 beeps") will be indicated. Note: Repeating to press the pad "0" will lower the loudness all the way to silent. (3 bEEP — loudest, 2 bEEP — middle, 1 bEEP — quietest, and 0 bEEP — silent)	
4		Press Prog pad. ⚡ "PROG" will stop blinking. That means that you have completed program. Three seconds later, "0" will appear.	
<ul style="list-style-type: none"> • Close the door. One minute later, Digital Display Window will go blank. 			

How to Operate NE - 2156/NE - 1856/NE - 1456

◆ For selecting length of tone “short beeps for 60 seconds”:

Example: To select short beeps for 60 seconds

PAD	INSTRUCTION	DIGITAL DISPLAY WINDOW
	Follow step 1-4 on page 14. DO NOT CLOSE THE DOOR!	
5 	Within three seconds after pressing Prog pad at step 4, press Number/Memory pad “0” once. ☛ “PROG” will start to blink and 2nd Stage Heating Indicator “2” (the length of beep tone “short beeps for 60 seconds”) will be indicated.	
6 	Press Prog pad. ☛ “PROG” will stop blinking. This means that you have completed programming. Three seconds later, “0” will appear.	
<ul style="list-style-type: none"> Close the door. One minute later, Digital Display Window will go blank. 		

G. PROGRAM LIST

PAD	INSTRUCTION	DIGITAL DISPLAY WINDOW
1	Open the door and leave it open. ☛ The oven lamp will turn on and “0” will appear.	
2 	While pressing Stop/Reset pad, press Start pad. ☛ All currently programmed information (the program set into each Number/Memory pad (A/B sides), Beep Tone, and Program Lock information) will continuously appear.	e.g.

H. CYCLE COUNTER

◆ To Read The Number of Times Each Memory Pad Has Been Used:

Example: To read times of Number/Memory pad “3” at A side (6666 times used)

PAD	INSTRUCTION	DIGITAL DISPLAY WINDOW
1	Open the door and leave it open. ☛ The oven lamp will turn on and “0” will appear.	
2 	While pressing Stop/Reset pad, press Number/Memory pad “3”. ☛ The times that the pressed Number/Memory pad has been used will appear.	e.g.

Note:

- When you want to read the times of each pad at B side, press Shift (A/B) pad while the display is still showing the number of cycles in step 2.

How to Operate NE - 2156/NE - 1856/NE - 1456

◆ To Read Total Cumulative Cycles That The Oven Has Been Used:

	PAD	INSTRUCTION	DIGITAL DISPLAY WINDOW
3		Close the door while the display is still showing the number of cycles that each pad has been used. ⚡ The total cumulative cycles that the oven has been used in Number/Memory pads at A/B sides and manual mode will appear.	

◆ To Read The Number of Cycles That The Oven Has Been Used In Manual Mode:

	PAD	INSTRUCTION	DIGITAL DISPLAY WINDOW
4		Open the door and leave it open. ⚡ The oven lamp will turn on and "0" will appear.	
5	+	While pressing Stop/Reset pad, press Power Level Selector pad. ⚡ The times that the oven has been used in manual mode will appear.	e.g.

I. AIR FILTER

Example: To program cleaning Air Filter every 600 hours

	PAD	INSTRUCTION	DIGITAL DISPLAY WINDOW
1		Open the door and leave it open. ⚡ The oven will turn on and "0" will appear.	
2		While pressing Start pad, close and open the door.	
3		Press Number/Memory pad "3". ⚡ The currently programmed hour will appear.	e.g.
4		Press Number/Memory pads "6", "0" and "0". ⚡ The programmed hour will appear. Note: up to 9999 hours	e.g.
5		Press Prog pad. ⚡ Three seconds later, "0" will appear.	

Note: When "FILT" sign appears in Digital Display Window, remove Air Filter and clean it with soapy water. Press Stop/Reset pad to clear the display.

To check the total number of hours used,

- ◆ Open the door and leave it open.
- ◆ Press Number/Memory pad "3" while pressing Start pad.
- ◆ The total number of hours used and "H" will appear in Digital Display Window.
e.g. If the oven has been used for 20 hours,

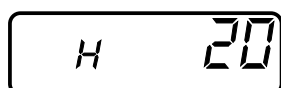

Three seconds later, "0" will appear in Digital Display Window.

Note: If the oven cuts out after short operation, check if Air Filter is clean before calling an engineer.

Installation Instructions for Stacking

IMPORTANT

1. Disconnect or unplug all units from the wall socket before attempting to stack.
2. For stacking installation, you must use the PANASONIC Joining Plate which is enclosed with this unit.

3. The following PANASONIC models only are suitable for stacking:
NE-1057, NE-1457, NE-1247, NE-1747, NE-1047, NE-1447, NE-1257, NE-1757, NE-1442, NE-1856, NE-1456, NE-1846, NE-1446, NE-2156, NE-2146
4. The maximum stacking height is the total heights of two units.

PREPARATION

Be sure the oven cavity is empty.

INSTALLATION

1. Stack the units and remove five screws (a) as shown in Fig.1.
2. Loosen the screw (b).
3. Projection on Joining Plate must face away from the oven. Place Joining Plate on the screw (b).
4. Attach and tighten five screws (a) and the screw (b). See Fig.2.
5. Ensure the top oven is at a safe and workable height.

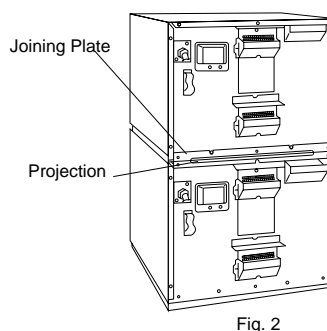
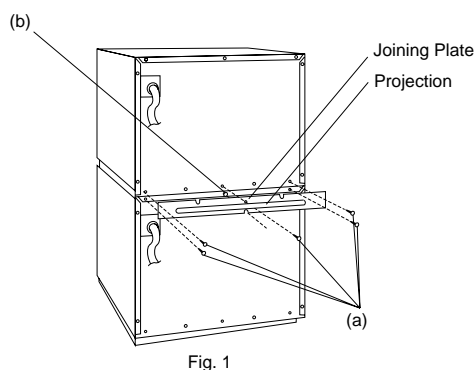

Self Diagnostics Failure Code Explanation

This oven monitors its operation and displays a Failure Code in Digital Display Window when a problem occurs. **What to do when a Failure Code appears:** Disconnect the oven from the electricity supply and wait more than ten seconds before reconnecting. If normal operation does not resume, follow the next chart.

CODE	PROBLEM	WHAT TO DO
F01	Too high temperature of exhausted air	The oven shuts off automatically. Disconnect the appliance from the electricity supply. The oven beeps continuously and resets for operation when cool. Move the oven to a cooler location. If the problem persists, call service agent.
F33-34	Defective thermistor circuit	The oven shuts off automatically. If the problem persists, call service agent.
F05	Defective memory IC	If the problem persists, call service agent. The oven will operate even if Failure Code appears, just not as designed. If the problem occurs during memory heating, press Stop/Reset pad. Then other memory program and manual heating will be possible.
F81-82	Defective relay circuit	If the problem persists, call service agent. The oven will operate even if Failure Code appears, just not as designed. Press Stop/Reset pad and try again.
F86-87	Defective relay circuit	The oven shuts off automatically. If the problem persists, call service agent.
F44	Defective control panel	The oven shuts off automatically. If the problem persists, call service agent.

Note: Above codes shown in Digital Display Window do not indicate all possible failures on the unit.

Care of Your Microwave Oven

1. Disconnect the appliance from the electricity supply before cleaning.
2. Keep the inside of the oven clean. If pieces of food or spilled liquids stick to the oven walls, or between door seal and door surface, they will absorb microwaves and may cause arcing or sparks. Wipe up all spills with a damp cloth. Kitchen detergent or Food Sanitizer Solution may be used if the oven gets very dirty. Do not use harsh detergents or abrasives.
3. The outside surface of this microwave oven should be cleaned with soap and water, then dried with a soft cloth. Make sure that water does not get into the back ventilation or control panel, since this can damage the unit.
4. The window of the door should be washed with very mild soap and water. Be sure to use a soft cloth. Never use window cleaner. The front door can be scratched by harsh soap or detergents.

CLEANING OF THE SPLATTER SHIELD

1. Locate the snap-in stoppers at the front corners of the splatter shield with both hands and pull them in and down. Take the splatter shield out of the oven cavity.

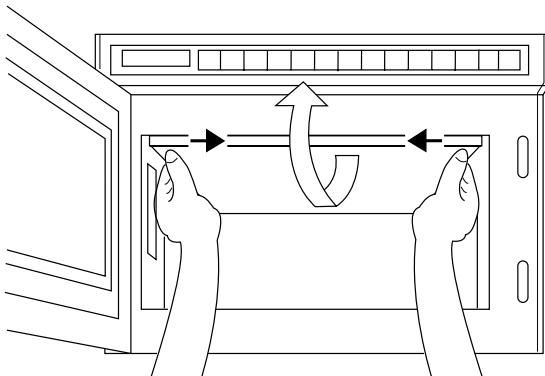

2. Rinse the splatter shield in soapy water or Food Sanitizer Solution. Dry.
3. Be sure to replace the shield before using the oven. Locate the pegs at the rear of the cavity first. Lift the front edge into place and the side stoppers should click into place.

CAUTION

Never operate the oven without the splatter shield securely in place. To do so will permanently damage the antenna in the roof of the oven.

CLEANING AIR FILTER

Clean the Air Filter regularly according to the following instructions. The oven may overheat if the Air Filter becomes clogged with dust and grease.

1. Remove Air Filter from the front bottom skirt by returning the right screw to the left. Then slide the filter to the right and lift it off the post at the left.

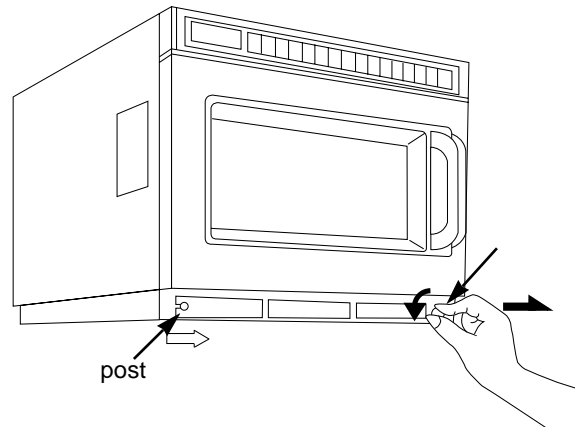

2. Wash this filter in warm soapy water.
3. Be sure to replace Air Filter before using the oven.

Cooking Instructions

COOKWARE

1. Heat-proof glassware, such as Pyroceram and Pyrex, is best suited for use in the microwave oven.
2. Do not use metal ware, ceramics trimmed with gold or silver, or any container with a metal content.
3. If "arcing" should occur, check the cookware carefully again for metal.
4. You may use ordinary glassware, chinaware, plastic-ware and paper-ware, when cooking food that requires a low temperature. Using this type of cookware for high temperature cooking may cause cracking or warping.
5. You can cook steamed vegetables in special "see-through" wrapping film, such as Saran Wrap, or wax paper. Do not cook in plastic bags.

CAUTION

Do not use METAL UTENSILS in this oven.

DEFROSTING FROZEN FOODS

1. If you try to completely defrost frozen foods in the microwave oven, uneven defrosting may occur due to the differences in the thickness and shape of the food. Drip may also result, and sometimes a part of the food cooks although other parts still remain frozen. In actual usage of frozen foods, you should not normally defrost them 100%. 70% defrosting in the microwave oven is ideal and helpful for the next cooking operation.
2. To defrost evenly, turn over or rearrange the food during defrosting.
3. To defrost fatty meat, heat it in the microwave oven for a short time and leave it to stand at room temperature, or heat it intermittently until defrosted.
4. When you defrost a whole chicken, or any frozen food of irregular shape, wrap legs or thin parts with aluminum foil. Otherwise thin parts will be defrosted faster and sometimes cooked before other parts have properly defrosted. For big pieces of meat, wrap the sides with aluminum foil so that they will be uniformly thawed by vertical microwaves only.
5. Ice should be removed during defrosting.

OTHER HELPFUL INSTRUCTIONS

FOR BEST RESULTS

1. When determining heating time for particular foods, always select minimum time and check occasionally during cooking for progress. The microwave oven cooks so quickly, therefore it is easy to overcook food.
2. Be careful of the cooking time for small quantities of foods, or foods with low water content. They may burn if cooked too long.
3. Do not use the oven for drying kitchen towels or napkins. They may burn if heated too long.
4. Do not try to boil eggs in the oven.
5. When you cook an egg be sure to pierce the yolk membrane prior to placing into the oven to prevent the egg bursting.
6. To achieve more even cooking result, give the dish a half-turn, or turn the food over.

Cooking Instructions

MICROWAVE BASICS

Fundamental principles determine the success of microwave food preparation.

They include:

1. **TEMPERATURE OF FOODS** — Frozen or refrigerated food items will require longer heating times to reach a desired serving temperature than foods from room temperature.
2. **FOOD COMPONENTS** — Foods high in sugar, salt, fats and moisture content heat faster because these properties attract microwave energy. Denser foods high in protein and fibre, absorb microwave energy slower which means a lengthier heating time.
3. **BULK/VOLUME** — The greater the mass of food, the longer it takes to heat.
4. **CONTAINERS** — Ceramic, paper, china, styrofoam, glass and plastic are suitable for use in microwave ovens with the following caution.

Heating foods with either high sugar or high fat content should be done **ONLY** in high temperature-resistant containers since these foods get very hot. Using styrofoam containers for these foods will cause the styrofoam to warp. Other low temperature restaurant glass or plastic platters may crack or warp under similar conditions.

DO NOT HEAT foods in a **SEALED** container or bag. Foods expand when heated and can break the container or bag.

5. **AVOID METAL** because it “bounces” the microwaves, causing uneven heating and sometimes even flashes, which may pit or mark the interior of the oven, the metal container or plate trim.
6. Heated liquids can erupt if not mixed with air. Do not heat liquids in the microwave oven without first stirring.

GENERAL GUIDELINES FOR HEATING IN A PANASONIC MICROWAVE OVEN

For specific time, see each food category for appropriate heating techniques, plus necessary pre-preparation of foods.

HEATING FOODS FROM REFRIGERATED TEMPERATURE

Foods stored in the refrigerator (5°C) should be covered before reheating with the exception of breads, pastries or any breaded product, which should be heated uncovered to prevent sogginess.

Most conventionally prepared foods should be slightly undercooked, and held in the refrigerator, so that overcooking does not occur during microwave heating.

Cooked items, such as vegetables, may be portion plated and covered for reheating without loss of colour, texture or nutritional content.

HEATING FOODS FROM ROOM TEMPERATURE

Food items such as canned entree, vegetables, etc. will require significantly less heating time than those from refrigerated temperatures.

IMPORTANT RECOMMENDATIONS

1. For best results it is recommended that foods conventionally prepared be slightly undercooked when subsequently heated in this oven.
2. **REMEMBER** that after the heating cycle has been completed, internal food temperatures continue to rise slightly in foods heated in this oven.
3. A major abuse of microwave applications is the category of breads, pastries and pies. They are drier than insides or fillings, they heat more slowly. Therefore, baked goods should **ONLY** be heated until the crust is warm to the touch (50°C-55°C).
4. **DO NOT OVERHEAT YOUR FOOD**: 99% of all food quality complaints of microwave heated foods can be traced to overheating.

Cooking/Defrosting Guide

The times given in the chart below are a **guideline only**. Many factors eg **starting temperature** of the food can affect the final heating time required. The cooking and defrosting times must be adjusted when necessary.

All times are tested using foods at **starting temperatures** as below;

Chilled foodsApprox. +5°C

Frozen foodsApprox. -18°C

Always check for the correct core temperature with a temperature probe to comply with current Government Food Hygiene Regulations.

Function	Food	Weight	Power Level	Approx. Time			
				NE-2156/2146	NE-1856/1846	NE-1456	
Defrosting	Fish Fillets	500 g	☞	8 min	8 min	8 min	
	Minced Beef	500 g	☞	5 min	5 min	5 min	
	Whole Chicken	1.36 kg	☞	25 min	25 min	25 min	
	Composite Dish	Multi portion	1.36 kg	☞	20 min	20 min	20 min
		Single portion	275 g	☞	8 min	8 min	8 min
	Apple Pie	1 portion	☞	1 min 15 s	1 min 15 s	1 min 15 s	
	Gateau	1 portion	☞	2 min	2 min	2 min	
	Bread Rolls	1 portion 50 g	☞	30 s	30 s	30 s	
Cooking from Chilled Raw Food	Scrambled Egg	2 eggs + 2 tbsp. milk	☞	20-25 s	25-30 s	40-50 s	
	Broccoli	500 g	☞	3 min	3 min 30 s	4 min 30 s	
	Fish Fillets	500 g	☞	2 min 20 s	2 min 45 s	3 min 30 s	
	Bacon	2 rashers	☞	40 s	50 s	1 min 10 s	
	Chicken Portions	500 g	☞	4 min	4 min 45 s	6 min	
Cooking and/or Reheating from Frozen	Peas	500 g	☞	3 min 20 s	4 min	5 min 10 s	
	Cooked Rice	167 g	☞	1 min 20 s	1 min 40 s	2 min 10 s	
	Cooked Sausages	x 3 (50 g each)	☞	50 s	1 min	1 min 15 s	
	Cooked Wings of Fire	x 7 pieces	☞	1 min 20 s	1 min 40 s	2 min 10 s	
	Cooked Boxed Cheeseburger	75 g	☞	50 s	1 min	1 min 15 s	
	Chocolate Fudge Cake	1 portion	☞	30 s	30 s	30 s	
	Reheating from Cooked Chilled	Lasagne	325 g	☞	3 min 20 s	4 min	5 min 30 s
Chilli		325 g	☞	2 min 30 s	3 min	3 min 30 s	
Apple Pie		1 portion	☞	14 s	16 s	20 s	
Pepper Sauce		100 ml	☞	40 s	50 s	1 min	
Baked Beans		100 ml	☞	40 s	50 s	1 min	
Soup		125 ml	☞	48 s	56 s	1 min 20 s	

- HINTS:**
- Do not cook/reheat/defrost directly onto the base of the oven — use a suitable container.
 - When defrosting **multi portions** of foods, turn over and break apart halfway through defrost time to allow better penetration of microwave energy.
 - **Solid/dense foods** should not be cooked from frozen as they will be overcooked round the edges before the centre has reached the required temperature.
 - **Cover** dishes where appropriate during cooking/reheating. This will retain moisture and prevent splashing/spillages.
 - Loosen lids/pierce clingfilm before cooking/reheating covered foods.
 - **Stir** or **shake** foods halfway through cooking/defrosting time to distribute the heat evenly.
 - Allow a **Stand Time** before food temperature is checked and/or offered for consumption.

Technical Specifications

	NE-1456	NE-1856 / NE-1846	NE-2156 / NE-2146
Power Source	230 - 240 V, 50 Hz, single phase		
Required Power	10.2 A, 2270 W	12.3 A, 2830 W	13.7 A, 3160 W
Output	HI 1400 W * MED 700W DEF 340 W	HI 1800 W * MED 900W DEF 340 W	HI 2100 W * MED 1050W DEF 340 W
Frequency	2450 MHz		
Outer Dimensions (W x D x H)	422 mm x 508 mm x 337 mm (16 ⁵ / ₈ " x 20" x 13 ³ / ₁₆ ")		
Cavity Dimensions (W x D x H)	330 mm x 310 mm x 175 mm (13" x 12 ³ / ₃₂ " x 6 ⁷ / ₈ ")		
Net Weight	30 kg		
Timer	NE-1456 / NE-1856 / NE-2156 30 min. (digital) / 10 touch pads Maximum programable time for single heating HI and MED power = 15 min. DEF power = 30 min.		
	NE-1846 / NE-2146 HI power = 25 min. MED and DEF power = 30 min.		

* IEC 705-88 Test Procedure

Specifications subject to change without notice.

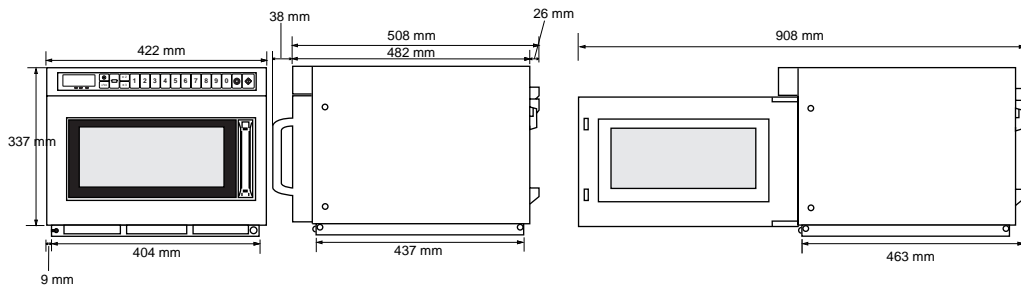

Matsushita Electric Industrial Co., Ltd.

Web Site: <http://www.panasonic.co.jp/global/>

A00033A80BP
F0701-0
Printed in Japan